



**Badger Meter**

## E-Series® Ultrasonic Meter

Cold Water Stainless Steel Meter, 5/8, 5/8 x 3/4, 3/4 and 1 inch  
NSF/ANSI Standard 61 Certified, Annex G

### DESCRIPTION

The E-Series® Ultrasonic meter uses solid-state technology in a compact, totally encapsulated, weatherproof, and UV-resistant housing, suitable for residential and commercial applications. Electronic metering provides information—such as rate of flow and reverse flow indication—and data not typically available through traditional, mechanical meters and registers. Electronic metering eliminates measurement errors due to sand, suspended particles and pressure fluctuations.

**Offered in four sizes and lay lengths, the Ultrasonic meter features:**

- Minimum extended low-flow rate lower than typical positive displacement meters.
- Simplified one-piece electronic meter and register that are integral to the meter body and virtually maintenance free.
- Sealed, non-removable, tamper-protected meter and register.
- Easy-to-read, 9-digit LCD display presents consumption, rate of flow, reverse-flow indication, and alarms.
- High resolution industry standard ASCII encoder protocol.

The Ultrasonic meter is available with an in-line connector for easy connection and installation to AMR/AMI endpoints. It is also available with a flying lead for field splice connection.

### APPLICATIONS

Use the Ultrasonic meter for measuring potable cold water in residential, commercial and industrial services. The meter is also ideal for non-potable, reclaimed irrigation water applications or less than optimum water conditions where small particles exist.

The Ultrasonic meter complies with applicable portions of ANSI/AWWA Standard C700 and NSF/ANSI Standard 61, Annex G. There is currently no AWWA standard that specifically addresses ultrasonic meters for residential applications.

### OPERATION & PERFORMANCE

As water flows into the measuring tube, ultrasonic signals are sent consecutively in forward and reverse directions of flow. Velocity is then determined by measuring the time difference between the measurement in the forward and reverse directions. Total volume is calculated from the measured flow velocity using water temperature and pipe diameter. The LCD display shows total volume and alarm conditions and can toggle to display rate of flow.

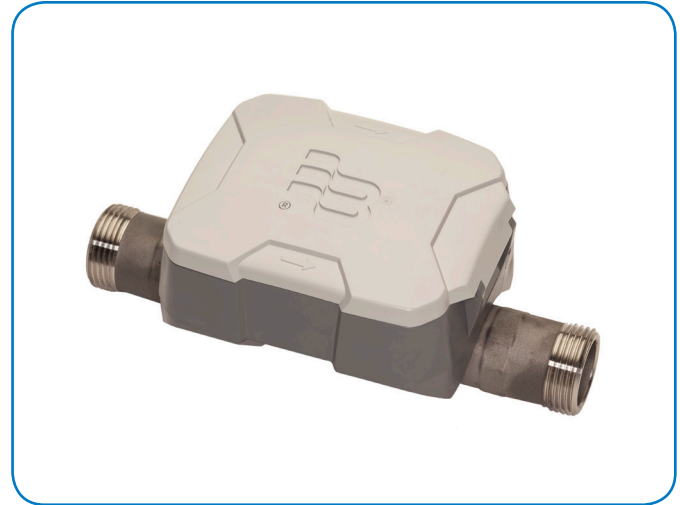

In the normal temperature range of 45...85° F (7...29° C), the Ultrasonic in.new meter in. consumption measurement is accurate to:

- $\pm 1.5\%$  over the normal flow range
- $\pm 3.0\%$  from the extended low flow range to the minimum flow value

### CONSTRUCTION

E-Series Ultrasonic meters feature a stainless steel, lead-free meter housing, an engineered polymer and stainless steel metering insert, a meter-control circuit board with associated wiring, LCD, and battery. Wetted elements are limited to the pressure vessel, polymer/stainless steel metering insert and the transducers. The electronic components are housed and fully potted within a molded, engineered polymer enclosure, which is permanently attached to the meter housing. The transducers extend through the stainless steel housing and are sealed by O-rings.

The metering insert holds the stainless steel ultrasonic reflectors in the center of the flow area, enabling turbulence-free water flow through the tube and around the ultrasonic signal reflectors. The metering insert's patented design virtually eliminates chemical buildup on the reflectors, ensuring long-term metering accuracy.

### METER INSTALLATION

The meter is completely submersible and can be installed using horizontal or vertical piping, with flow in the up direction. The meter will not measure flow when an in.empty pipe in. condition is experienced. An empty pipe is defined as a condition when the flow sensors are not fully submerged.

## SPECIFICATIONS

E-Series Ultrasonic Meter Size	5/8 in. (15 mm)	5/8 x 3/4 in. (15 mm)	3/4 in. (20 mm)	1 in. (25 mm)
<b>Operating Range</b>	0.1...25 gpm	0.1...25 gpm	0.1...32 gpm	0.4...55 gpm
<b>Extended Low-Flow Rate</b>	0.05 gpm	0.05 gpm	0.05 gpm	0.25 gpm
<b>Maximum Continuous Operation</b>	25 gpm	25 gpm	32 gpm	55 gpm
<b>Pressure Loss</b>	4.3 psi at 15 gpm	2.3 psi at 15 gpm	2.0 psi at 15 gpm	1.8 psi at 25 gpm
<b>Reverse Flow - Maximum Rate</b>	4.0 gpm	4.0 gpm	4.0 gpm	9.0 gpm
<b>Operating Performance</b>	In the normal temperature range of 45...85° F (7...29° C), new meter consumption measurement is accurate to: <ul style="list-style-type: none"> <li>• ±1.5% over the normal flow range</li> <li>• ±3.0% from the extended low flow range to the minimum flow value</li> </ul>			
<b>Storage Temperature</b>	- 40...140° F (- 40...60° C)			
<b>Maximum Ambient Storage (Storage for One Hour)</b>	150° F (72° C)			
<b>Measured-Fluid Temperature Range</b>	34...140° F (1°...60° C)			
<b>Humidity</b>	0...100% condensing; meter is capable of operating in fully submerged environments			
<b>Maximum Operating Pressure of Meter Housing</b>	175 psi (12 bar)			
<b>Register Type</b>	Straight reading, permanently sealed electronic LCD; digits are 0.28 in. (7 mm) high			
<b>Register Display</b>	<ul style="list-style-type: none"> <li>• Consumption (up to nine digits)</li> <li>• Rate of flow</li> <li>• Alarms</li> <li>• Unit of measure factory programmed for gallons, cubic feet and cubic meters</li> </ul>			
<b>Register Capacity</b>	<ul style="list-style-type: none"> <li>• 10,000,000 gallons</li> <li>• 1,000,000 cubic feet</li> <li>• 100,000 cubic meters</li> </ul>			
<b>Totalization Display Resolution</b>	<ul style="list-style-type: none"> <li>• Gallons: 0.XX</li> <li>• Cubic feet: 0.XXX</li> <li>• Cubic meters: 0.XXXX</li> </ul>			
<b>Battery</b>	3.6-volt lithium thionyl chloride; battery is fully encapsulated within the register housing and is not replaceable; 20-year battery life			

## MATERIALS

<b>Meter Housing</b>	316 stainless steel
<b>Measuring Element</b>	Pair of ultrasonic sensors located in the flow tube
<b>Register Housing &amp; Lid</b>	Engineered polymer
<b>Metering Insert</b>	Engineered polymer & stainless steel
<b>Transducers</b>	Piezo-ceramic device with wetted surface of stainless CrNiMo

## PHYSICAL DIMENSIONS

E-Series Ultrasonic Meter Size	5/8 in. (15 mm)	5/8 x 3/4 in. (15 mm)	3/4 in. (20 mm)	1 in. (25 mm)
Size Designation X Lay Length	5/8 x 7-1/2 in.	5/8 x 3/4 x 7-1/2 in.	3/4 x 7-1/2 in. or 3/4 x 9 in.	1 x 10-3/4 in.
Weight (without AMR)	2.2 lb	2.1 lb	3/4 x 7-1/2 in.: 2.1 lb 3/4 x 9 in.: 2.4 lb	3.1 lb
See illustration below for Measurement Designations.				
Length (A)	7.5 in.	7.5 in.	7.5 in. or 8.98 in.	10.745 in.
Height (B)	2.404 in.	2.404 in.	2.404 in.	2.529 in.
Height (C)	3.014 in.	3.014 in.	3.094 in.	3.359 in.
Width (D)	3.898 in.	3.898 in.	3.898 in.	3.898 in.
Bore Size	5/8 in.	3/4 in.	3/4 in.	1 in.
Coupling Nut & Spud Thread	3/4 in. x 14 NPSM	1 in. x 11-1/2 NPSM	1 in. x 11-1/2 NPSM	1-1/4 in. x 11-1/2 NPSM
Tailpiece Pipe Thread (NPT)	1/2 in.	3/4 in.	3/4 in.	1 in.
Service Pipe Thread (NPT)	1/2 in.	3/4 in.	3/4 in.	1 in.

## Measurement Designations

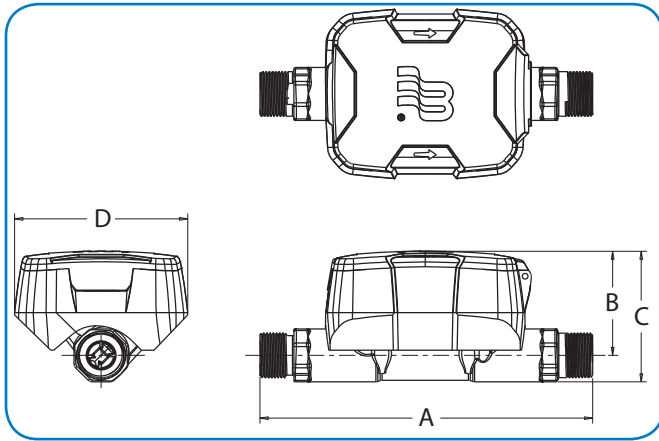

## PRESSURE LOSS CHART

Rate of Flow in Gallons per Minute (gpm)

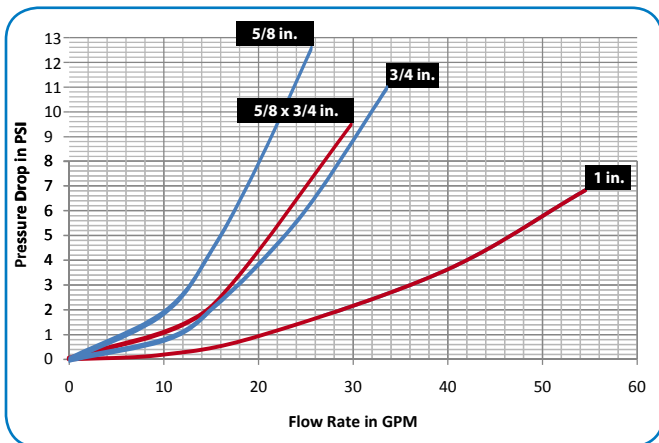

## ACCURACY CHARTS

Rate of Flow in Gallons per Minute (gpm)

**5/8 in. Meter**

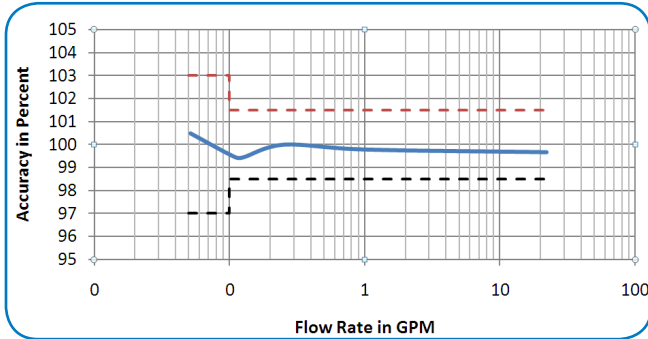

**5/8 x 3/4 in. Meter**

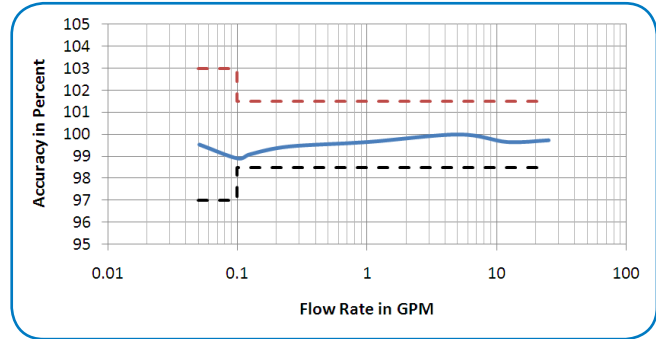

**3/4 in. Meter**

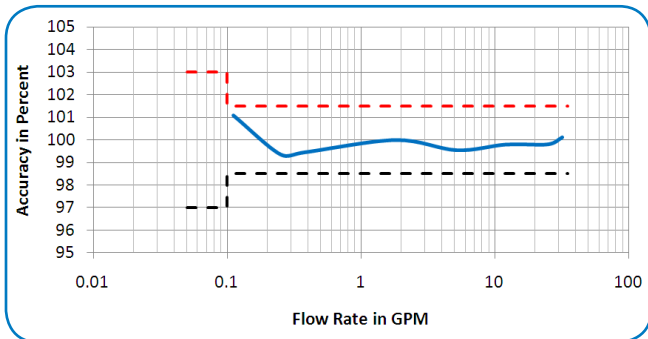

**1 in. Meter**

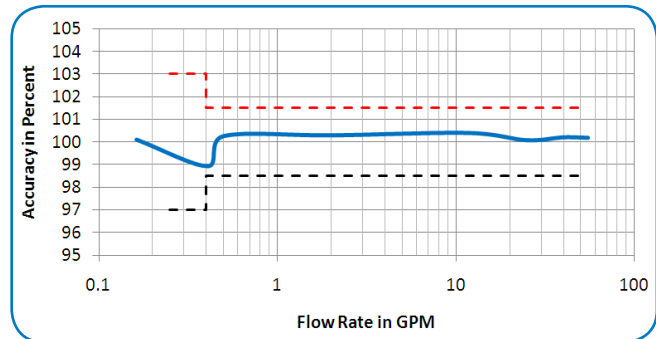

## Making Water Visible®

E-Series, GALAXY, Making Water Visible and ORION are a registered trademarks of Badger Meter, Inc. Other trademarks appearing in this document are the property of their respective entities. Due to continuous research, product improvements and enhancements, Badger Meter reserves the right to change product or system specifications without notice, except to the extent an outstanding contractual obligation exists. © 2016 Badger Meter, Inc. All rights reserved.

[www.badgermeter.com](http://www.badgermeter.com)

The Americas | Badger Meter | 4545 West Brown Deer Rd | PO Box 245036 | Milwaukee, WI 53224-9536 | 800-876-3837 | 414-355-0400  
 México | Badger Meter de las Americas, S.A. de C.V. | Pedro Luis Ogazón N°32 | Esq. Angelina N°24 | Colonia Guadalupe Inn | CP 01050 | México, DF | México | +52-55-5662-0882  
 Europe, Middle East and Africa | Badger Meter Europa GmbH | Nurtinger Str 76 | 72639 Neuffen | Germany | +49-7025-9208-0  
 Europe, Middle East Branch Office | Badger Meter Europe | PO Box 341442 | Dubai Silicon Oasis, Head Quarter Building, Wing C, Office #C209 | Dubai / UAE | +971-4-371 2503  
 Czech Republic | Badger Meter Czech Republic s.r.o. | Maříkova 2082/26 | 621 00 Brno, Czech Republic | +420-5-41420411  
 Slovakia | Badger Meter Slovakia s.r.o. | Racianska 109/B | 831 02 Bratislava, Slovakia | +421-2-44 63 83 01  
 Asia Pacific | Badger Meter | 80 Marine Parade Rd | 21-06 Parkway Parade | Singapore 449269 | +65-63464836  
 China | Badger Meter | 7-1202 | 99 Hangzhong Road | Minhang District | Shanghai | China 201101 | +86-21-5763 5412  
 Switzerland | Badger Meter Swiss AG | Mittelholzerstrasse 81 3006 Bern | Switzerland | +41-31-932 01 11